

EMCO

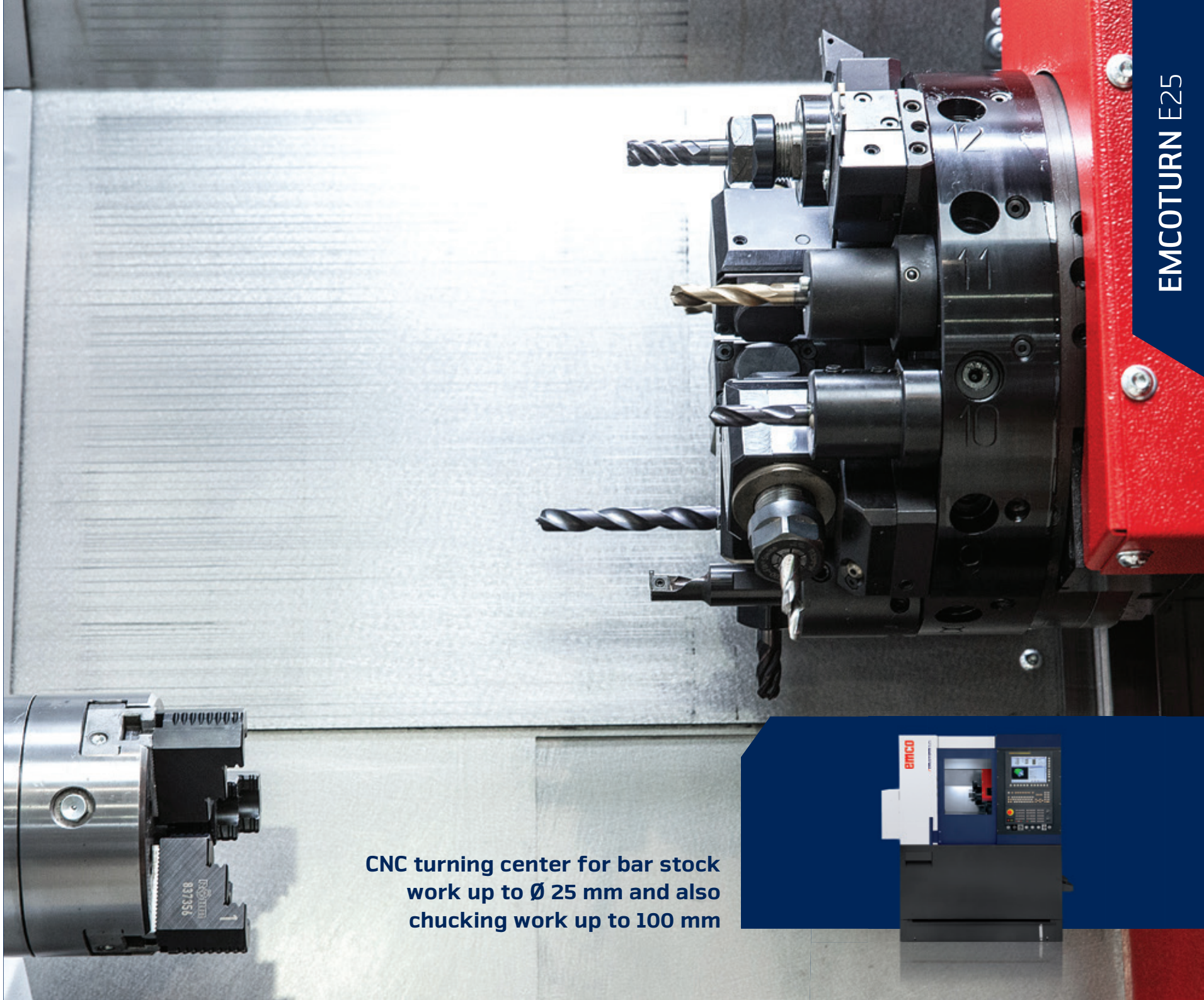

EMCOTURN E25

**CNC turning center for bar stock
work up to \varnothing 25 mm and also
chucking work up to 100 mm**



EMCOTURN E25

Small workpieces present special challenges. The EMCOTURN E25 has been designed to meet exactly these challenges. Mostly these are workpieces from the fields of precision engineering, medical technology, electronics, optics or jewellery industry, but also in the automotive sector and in general mechanical engineering, small parts of high quality are needed. A solid and compact machine construction with precision spindle, 12-fold tool turret and tailstock enables the machining of workpieces both from bars and inserts. For the automatic feeding of raw material or blanks a bar loader or a robot can be offered. According to requirements a FANUC or SIEMENS control technology can be used for the built up. Naturally also inclusive of Dialogue programming.



Plug
(Stainless steel)

1 WORK AREA

- / 60° inclined bed
- / Free chip fall
- / Optimal insight
- / Perfect ergonomics

2 MAIN SPINDLE

- / High power
- / Thermostable construction
- / Large range of speeds
- / Bar capacity Ø 25,5 mm

3 TOOL TURRET

- / 12 positions VDI 16 axially positioned
- / With 6 driven positions (optional)
- / Internal coolant supply
- / Synchronised tapping

4 CONTROL

- / Cutting-edge digital control technology
- / Sinumerik 828D or Fanuc Oi TF includes ShopTurn or ManualGuide i
- / Colour LCD monitor 15"



Machine with optional equipment

5 SHELF

- / Space for measuring devices and operating tools
- / Optional for the Sinumerik PC keyboard

6 MACHINE STAND

- / Small footprint
- / Easy transport
- / Easy installation
- / Lateral opening for chip conveyor

7 FINISHED PARTS CONTAINER

- / Amply dimensioned
- / Pull-out design
- / Excellent accessibility

8 COOLANT TANK

- / Can be pulled out towards the front
- / Extremely easy to clean
- / Fill level sight glass
- / Swivelling coolant pump

WORKPIECES

1 ENGRAVING USING CYLINDER INTERPOLATION

2 CONTOUR MILLING USING CYLINDER INTERPOLATION

3 POLYGON TURNING OR PROFILE MILLING WITH C-AXIS INTERPOLATION

4 TAPPED OR WHIRLED INSIDE THREAD

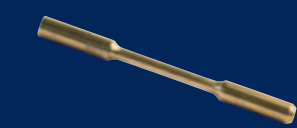

Tensile test (Brass)



Fitting (Stainless steel)



Ring (Gold)



Valve cap (Stainless steel)



Plug (Stainless steel)

VALIDATED QUALITY

ROUNDNESS AND SURFACE QUALITY

Material:	Brass (Cu Zn 40 Pb 2)
Cutting tool:	Carbide insert CCGX 09 T3 04-AL
Turning diameter:	∅ 35 mm
Cutting speed:	300 m/min
Feed rate:	0,025 mm/rev
Cutting depth:	0,03 mm

AS MEASURED ...*

Roundness:	0,5 μm
Surface finish:	Ra = 0,163 μm

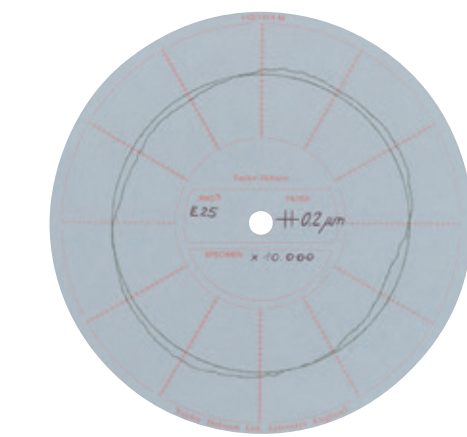
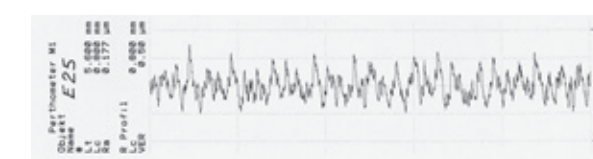

REPEAT ACCURACY

Material:	Steel – 16 Mn Cr 5
Turning diameter:	∅ 35 h6
Tolerance:	16 μm
Spindle speed:	2000 rpm
Feed rate:	0,08 mm/rev
Cutting depth:	0,2 mm

LONG TERM MACHINING ACCURACY: 4 μm

AS MEASURED ...*

Range:	4 μm
Cm value:	2,62

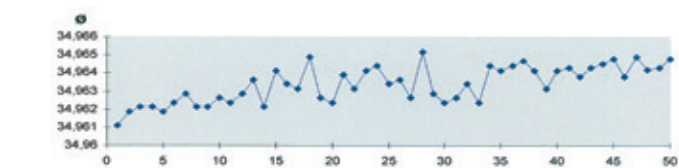

*...The actual results may be affected by a number of factors, such as warm up cycles, speeds, feeds, tools, coolant, material, ambient temperature, etc., should be higher or lower than those listed.

TECHNICAL HIGHLIGHTS

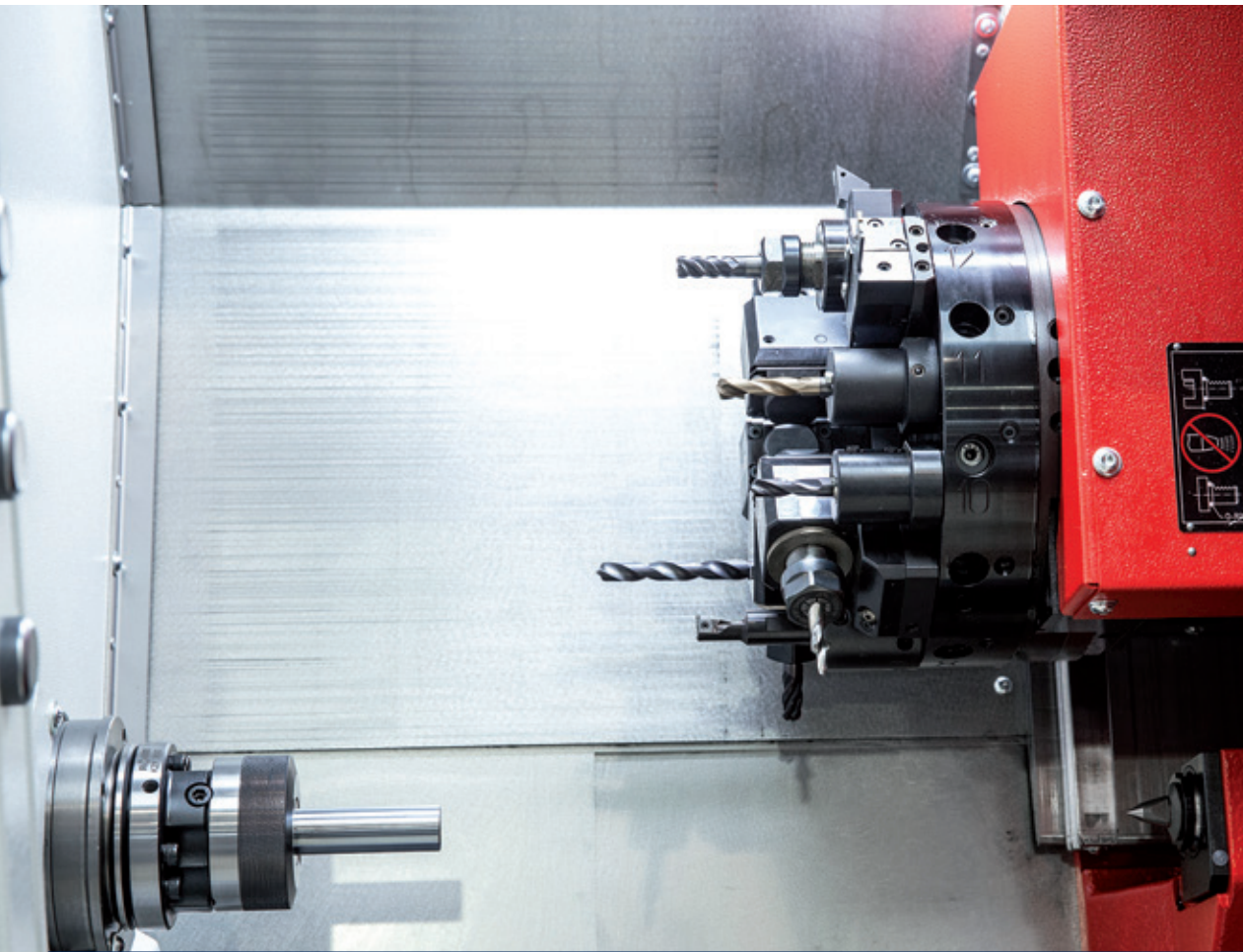

PUSH-TYPE COLLET CHUCK

This dead-length collet chuck allows to feed the bar stock against a bar stop without pull-back effect. It has been designed for the use of DIN collets (148E). Clamping range: \varnothing 3-24 mm

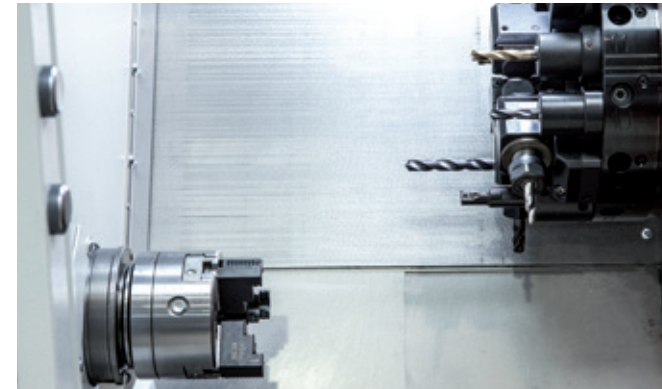

3-JAW POWER CHUCK

Thanks to the KFD-HS 95/3 power chuck, the EMCOTURN E25 is also capable of processing flange parts. With a passage of 26 mm, shaft parts can be clamped without replacing the clamping device by a collet chuck.

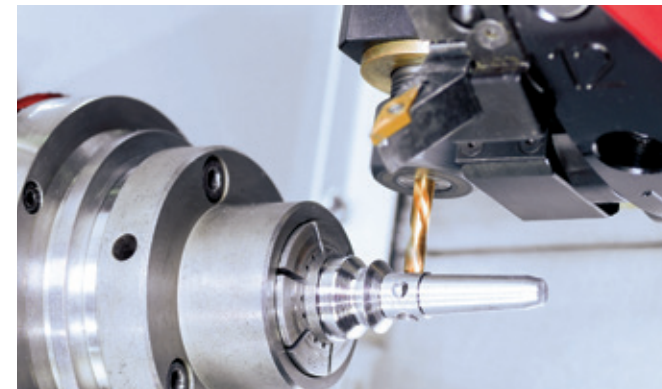

PULL-TYPE COLLET CHUCK

The compact collet chuck for 5C (385E) collets ensures collision-free processing of small parts. Clamping range: \varnothing 2-26 mm.

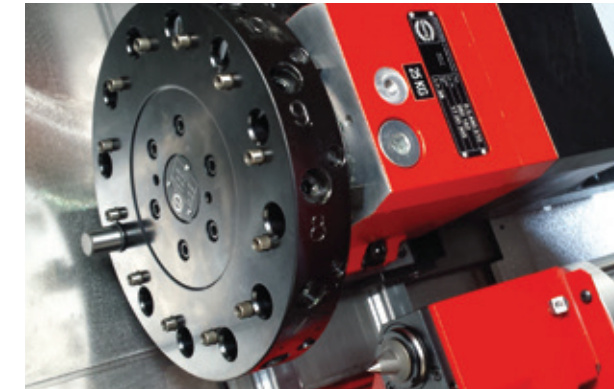

TOOL TURRET WITHOUT MILLING DRIVE

12-station turret VDI 16 for stationary tool holders. With this turret, precision parts can be turned and drilled easily.

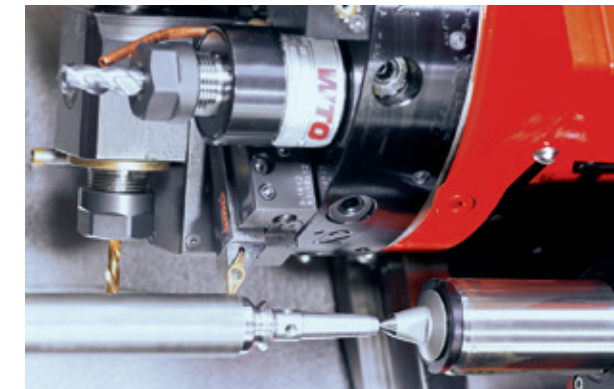

TAILSTOCK

Long workpieces can be supported by the tailstock, which allows for high-precision machining. The tailstock is positioned and clamped by hand. The quill with 120 mm stroke is activated automatically via M-functions.

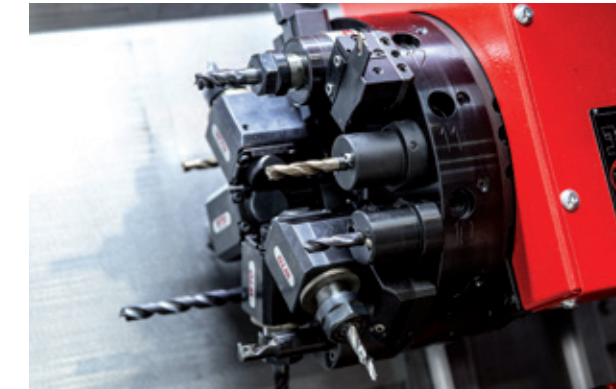

TOOL TURRET WITH MILLING DRIVE

12-station turret VDI 16 for stationary and driven tool holders. 6 positions on the turret can be used for milling operations. This allows more complex workpieces to be produced. Only the respective position in use is driven. The remaining positions are not active.



SWING-OUT COOLANT PUMP

For quick and easy cleaning of the coolant sump, the coolant pump can be swung out to the side. This allows the sump to be pulled out to the front and cleaned.

HIGHLIGHTS

- / Stable machine bed
- / Pre-tensioned linear guides
- / Maximum thermostability
- / Best machining precision
- / Most compact machine construction
- / State-of-the art Siemens or Fanuc control technology
- / Made in the Heart of Europe

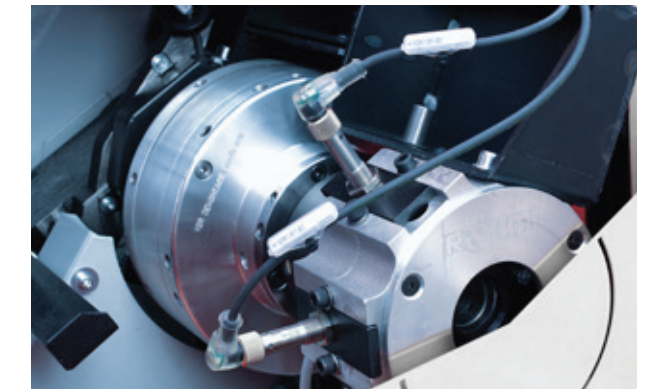

CLAMPING CYLINDER WITH CLAMPING STROKE MONITORING

The clamping stroke monitoring on the pneumatic clamping cylinder guarantees safe unmanned operation of the machine. A rotary encoder mounted directly on the headstock enables precise positioning of the C-axis for drilling and milling operations. The indexing disc allows mechanical locking of the spindle in 3° steps.

OPTIONS

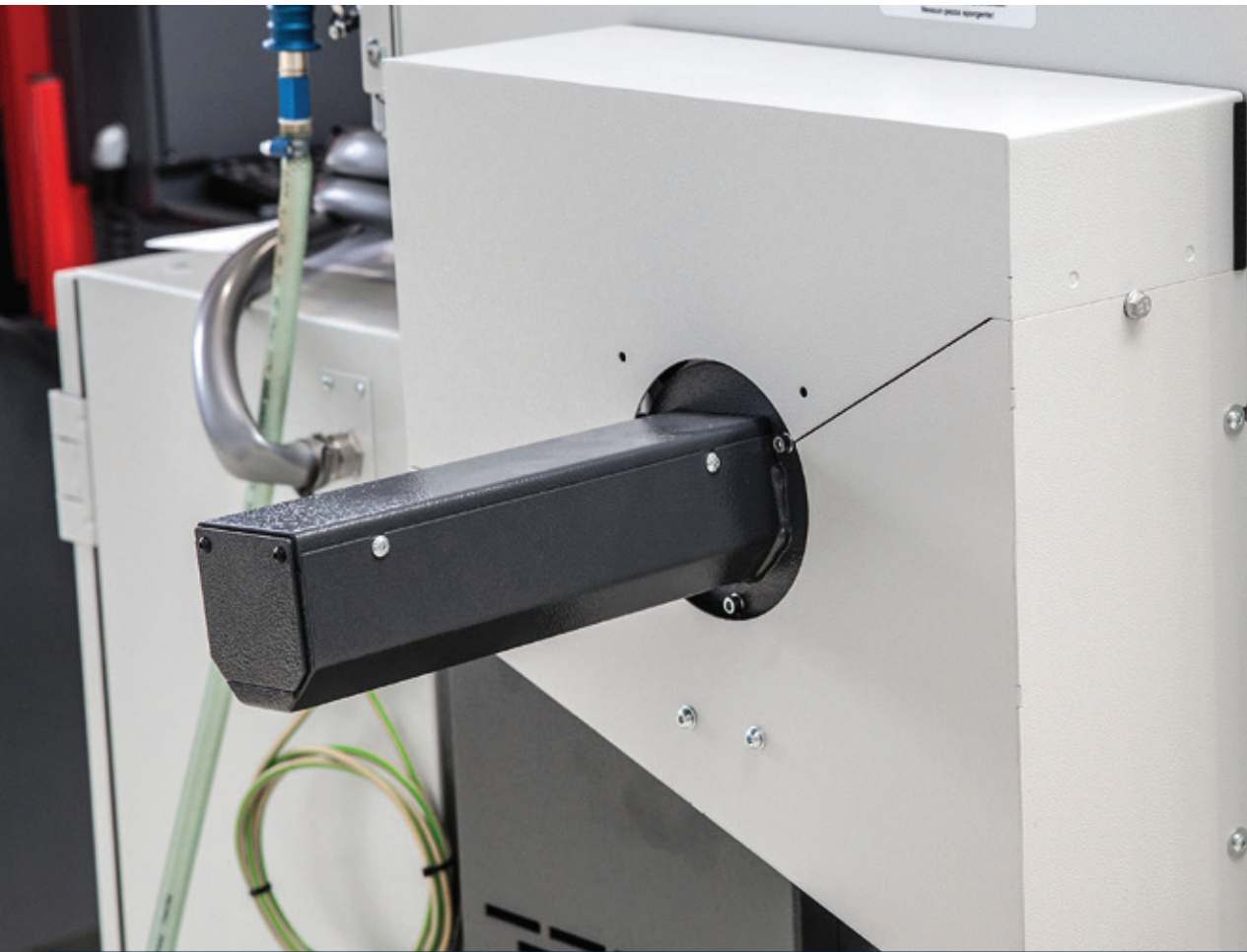

SPINDLE EXTENSION FOR SHORT BAR FEEDER

The spindle extension can be offered for processing cut-to-length material bars up to a length of 800 mm. The cut-to-length bar material can then be fed either manually or with a short bar loader.



EMCO SHORT LOADER

In order to tackle the ever-increasing pressure relating to machine footprints, EMCO has developed the most compact short loader available on the market: EMCO SL 1200.



OPERATING PANEL

The operating buttons and the diameter adjustment are located on the front side of the SL 1200. If required, the loader can easily be moved 400 mm to the left.

MACHINE LAYOUT

Machine layout E25

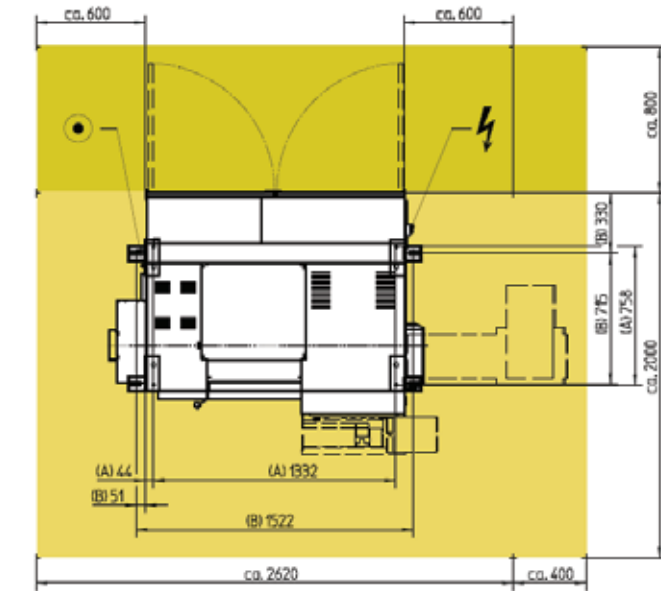
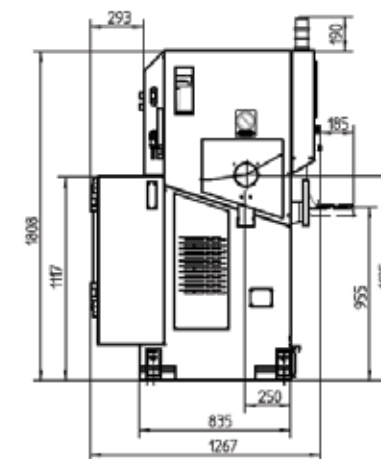
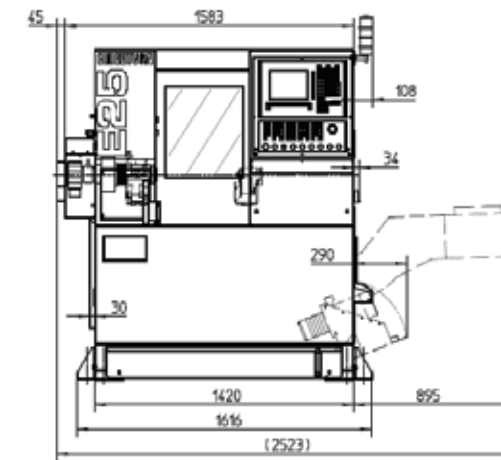

Indications in millimeters

WORK AREA

Work area E25 without driven tools

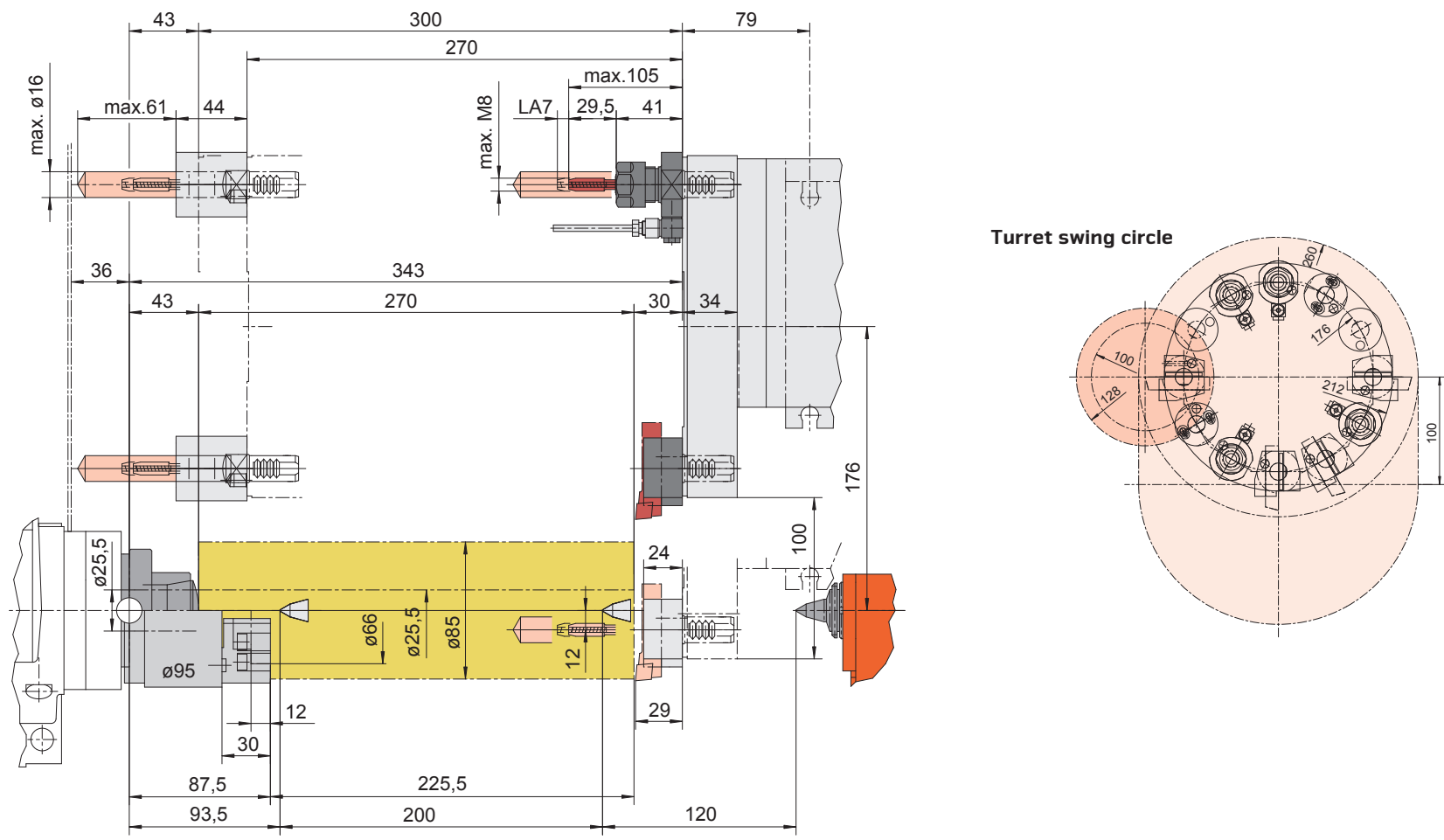

Indications in millimeters

WORK AREA

Work area E25 with driven tools

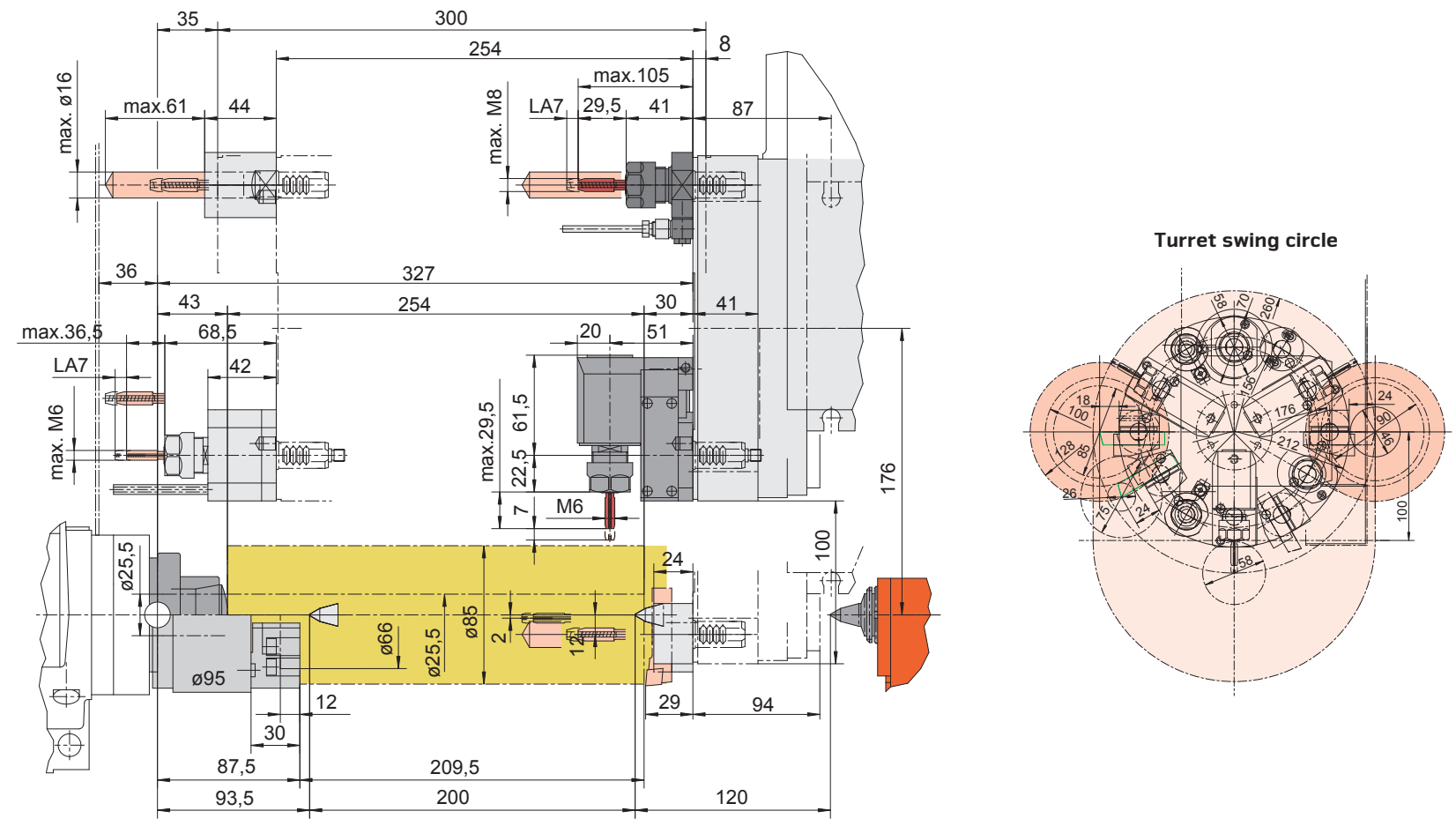

Indications in millimeters

POWER AND TORQUE

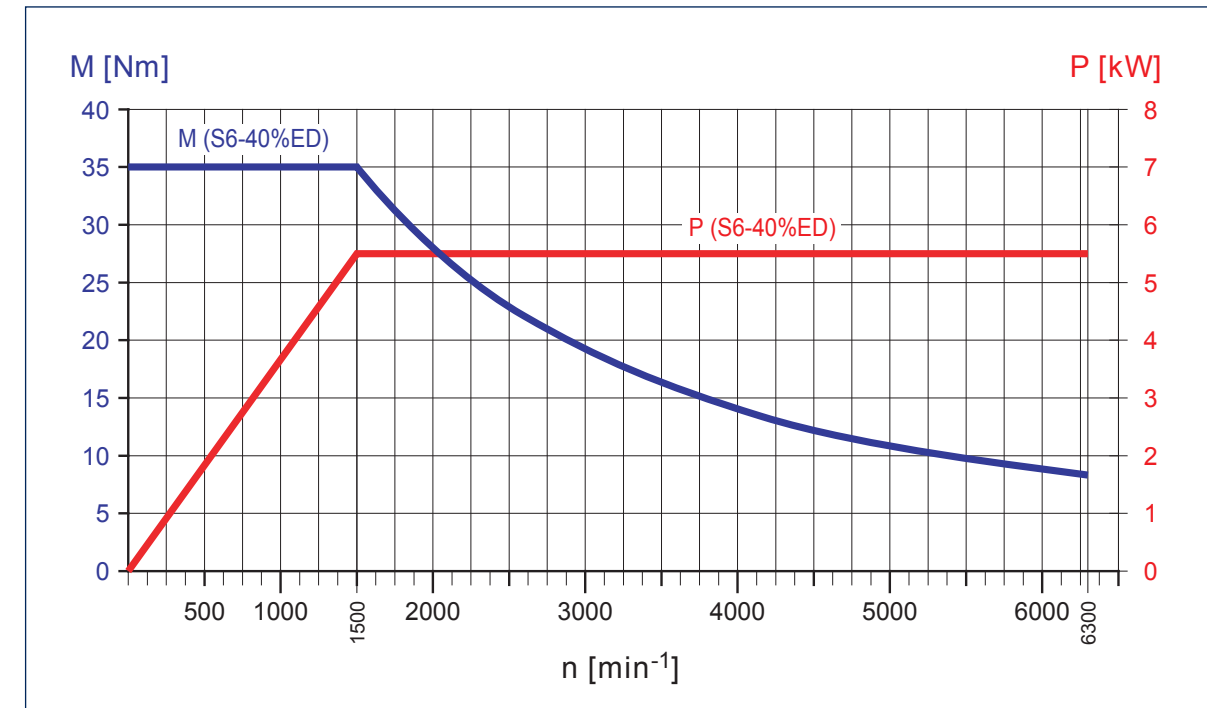

Motor characteristic curve main spindle

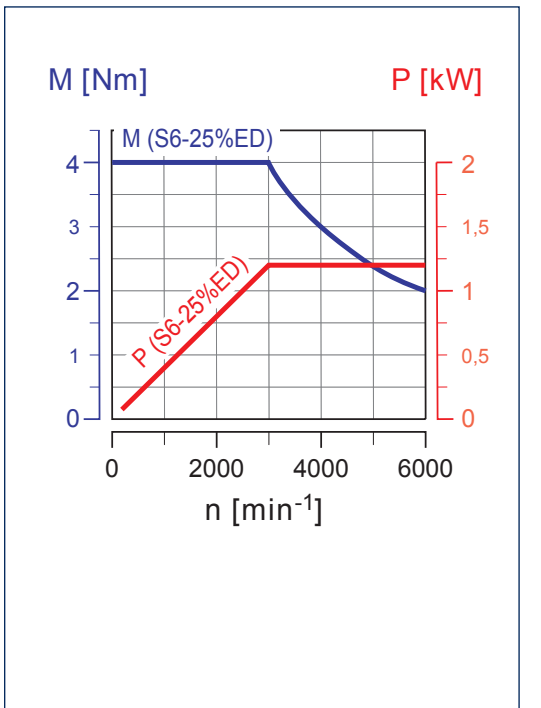

Motor characteristic curve tool turret (driven tools)

TECHNICAL DATA

Work area

Swing over bed	Ø 250 mm
Swing over cross slide	Ø 85 mm
Maximum distance between centers	405 mm
Maximum turning diameter	Ø 85 mm
Maximum turning length	255 mm
Maximum bar-stock diameter	Ø 25,5 mm

Travel

Travel in X	100 mm
Travel in Z	300 mm

Main spindle

Speed range	60 – 6300 rpm
Drive performance	5,5 kW
Spindle torque	35 Nm
Spindle nose	Ø 70 h5
Spindle bearing (inner diameter at front)	50 mm
Spindle bore	30 mm

C-axis

Resolution	0,001°
Rapid motion speed	1000 rpm
Spindle indexing	3°

Tool turret

Number of tool positions	12
Tool holding shaft in accordance with VDI (DIN 69880)	16
Tool cross-section for square tools	12 x 12 mm
Shank diameter for boring bars	Ø 16 mm

Driven tools / Coupling DIN 5480

Number of stations	6
Drive performance	1,2 kW
Maximum torque	4 Nm
Speed range	0 – 6000 rpm

Feed drives

Rapid traverse X / Z	15 / 24 m/min
Feed force in the X- / Z-axis	3000 / 3500 N
Positioning scatter Ps (according VDI 3441) X / Z	2 / 2 µm*

Tailstock

Quill stroke	120 mm
Quill thrust	800 – 2500 N
Quill diameter (live center integrated)	35 mm
Quill bore taper	integrated live-centre

Coolant system

Tank volume	140 liters
Pump performance (optional)	3,5 (8) bar

Dimensions and weight

Height of spindle center	1131 mm
Machine height	1820 mm
Required space for machine L x D	1700 x 1270 mm
Total weight	1400 kg

Safety devices CE compliant

*...for machines including laser measurement and pitch error compensation

beyond standard /

EMCO GmbH / Salzburger Str. 80 / 5400 Hallein-Taxach / Austria / T +43 6245 891-0 / F +43 6245 86965 / info@emco.at

www.emco-world.com